

OPERATION, PARTS AND SAFETY MANUAL

SIGNODE®

VT-16/19

**TENSION-WELD®
STRAPPING TOOL**

**IMPORTANT!
DO NOT DESTROY**

**It is the customer's responsibility to
have all operators and servicemen
read and understand this manual.**

Contact your local Signode representative
for additional copies of this manual.

READ ALL INSTRUCTIONS BEFORE OPERATING THIS SIGNODE PRODUCT

⚠️ WARNING

READ THESE INSTRUCTIONS CAREFULLY.

FAILURE TO FOLLOW THESE INSTRUCTIONS CAN RESULT IN SEVERE PERSONAL INJURY.

GENERAL SAFETY CONSIDERATIONS

1. STRAP BREAKAGE HAZARD.

Improper operation of the tool or sharp corners on the load can result in strap breakage during tensioning, which could result in the following:

- A sudden loss of balance causing you to fall.
- Both tool and strap flying violently towards your face.

Failure to place the strap properly around the load or an unstable or shifted load could result in a sudden loss of strap tension during tensioning. This could result in a sudden loss of balance causing you to fall.

Read the tool's operating instructions. If the load corners are sharp use edge protectors. Place the strap correctly around a properly positioned load.

- Positioning yourself in-line with the strap, during tensioning and sealing, can result in severe personal injury from flying strap or tool. When tensioning or sealing, position yourself to one side of the strap and keep all bystanders away.
- Using strap not recommended for this tensioner can result in strap breakage during tensioning. Use the correct Signode products for your application.

2. TRAINING.

This tool must not be used by persons not properly trained in its use. Be certain that you receive proper training from your employer. If you have any questions contact your Signode Representative.

3. EYE INJURY HAZARD.

Failure to wear safety glasses with side shields can result in severe eye injury or blindness. Always wear safety glasses with side shields which conform to ANSI Standard Z87.1 or EN 166.



4. FALL HAZARD.

Maintaining improper footing and/or balance when operating the tool can cause you to fall. Do not use the tool when you are in an awkward position.

5. CUT HAZARD.

Handling strap or sharp parts could result in cut hands or fingers. Wear protective gloves.



⚠ WARNING

6. TOOL CARE.

Take good care of the tool. Inspect and clean it daily, lubricate it weekly and adjust when necessary. Replace any worn or broken parts.

7. WORK AREA.

Keep work areas uncluttered and well lighted.

Several types of strap can be used with this tool. Use the correct Signode products for your application. If you need help contact your Signode Representative.

SAFETY PROCEDURES FOR TOOL OPERATION

Before using this tool, read its Operation and Safety instructions.

- Do not exceed the operating air pressures stated elsewhere in the manual.
- Use Signode's approved filter-regulator-lubricator unit (P-008559).
- Never operate a pneumatic tool with a bottled air or gas source.
- For tension adjustments, follow instructions in this manual. For all other adjustments, repairs or cleaning of the tool, disconnect air supply.
- This tool is a Tension Weld® type sealer. A properly made joint will appear as shown in the illustration. If the joint does not appear as shown, then the operator must proceed as follows:



- A. Insure that the tools operating instructions are being followed before applying another strap.
- B. Cut the strap off and apply another.

If the joint still does not appear as shown, then inspect the tool for worn and/or damaged parts. Replace tool parts as needed. **NEVER HANDLE OR SHIP ANY LOAD WITH IMPROPERLY FORMED JOINTS.** Misformed joints may not secure the load and could cause serious injury.

- Tuck strap end back into the dispenser when not in use.

CUTTING TENSIONED STRAP

Use only cutters designed for cutting strap; never use claw hammers, crowbars, chisels, axes or similar tools. Such tools will cause the strap to fly apart with hazardous force. Before using any Signode product, read its Operation and Safety Manual.

TABLE OF CONTENTS

	Page		Page
General Safety Instructions	2	Parts List, Tool	20
Specifications	4	Parts List, Air Motors	24
Major Components	5	Troubleshooting	27
Pneumatic Information	6	Maintenance	31
Strap Size Conversion	11	Overhead Suspension	32
Operating Instructions	12	Tool Options	33
Adjustments	16		

VT-16 Strapping Tool
Part No. 423990

VT-19 Strapping Tool
Part No. 423991

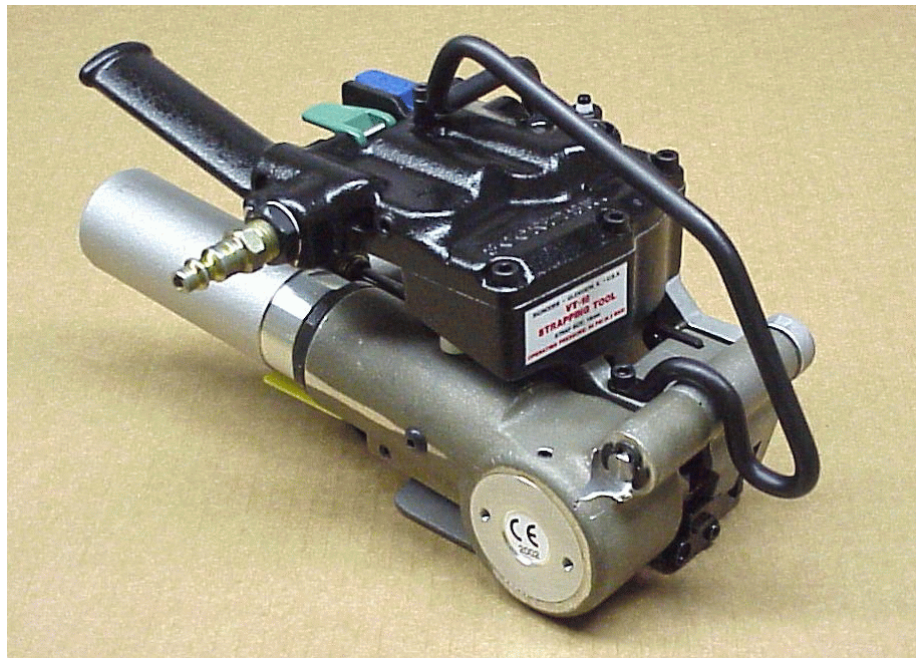

SPECIFICATIONS

MODEL	STRAP		
	TYPE	WIDTH	THICKNESS
VT-16	High Strength Tenax	16mm	Up to 0.055" (1.4mm)
VT-19	High Strength Tenax	19mm	Up to 0.055" (1.4mm)

NOTE: VT-16 tools are factory configured for use with 16mm Tenax Strapping.
VT-19 tools are factory configured for use with 19mm Tenax Strapping.

MAJOR COMPONENTS

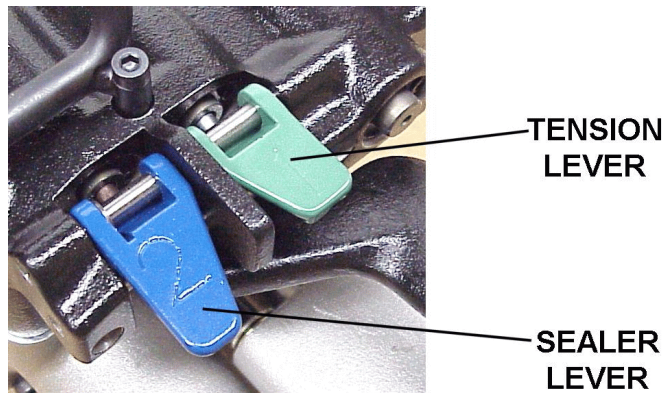
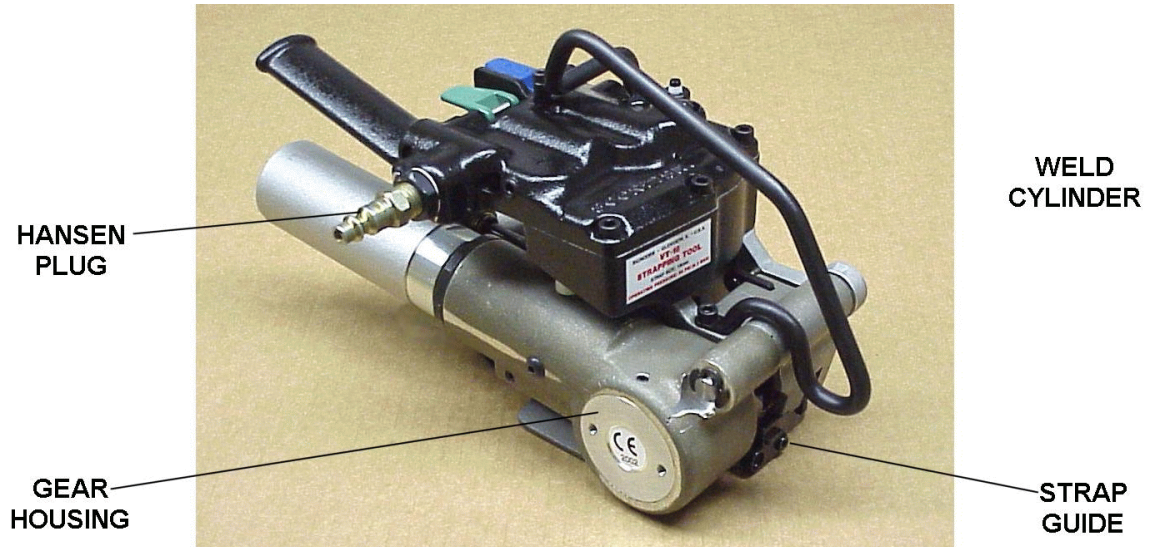
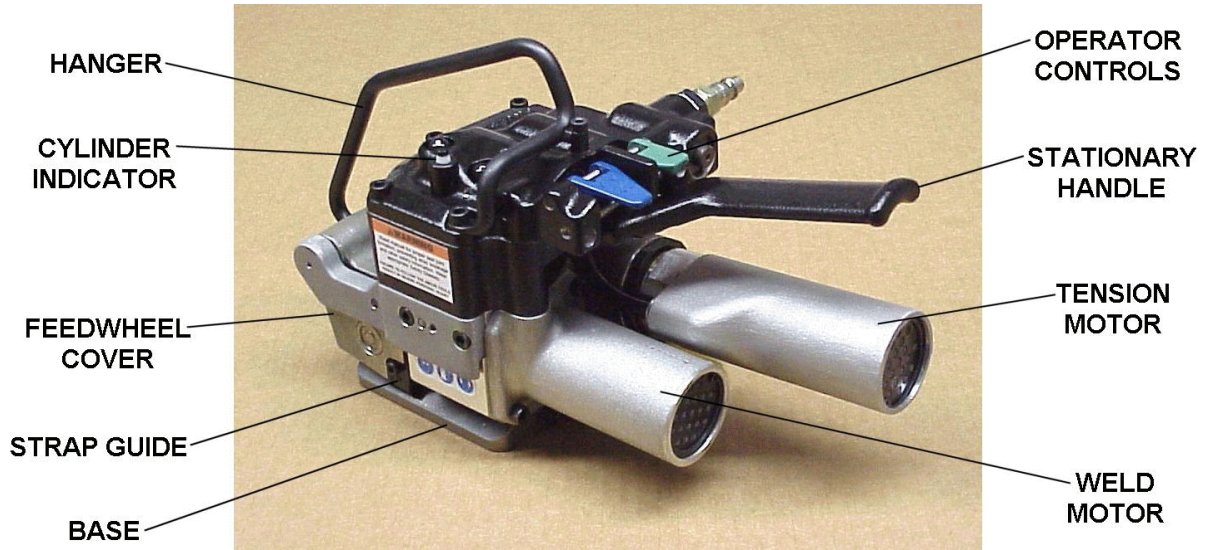

PNEUMATIC INFORMATION

AIR PRESSURE REQUIREMENTS

The VT tools are designed to operate at an air pressure of 90 psig (6.2 Bar).

AIR PRESSURE VS. PERFORMANCE

The air pressure supplied to the VT tool must be a minimum of 85 psig (5.7 Bar) If the air supply pressure can be adjusted within a range from 85 psi to 90 psi (5.7 - 6.2 Bar) the VT tool's performance can be fine tuned to a particular application or operation preferences. Changing the VT air supply pressure to the tool will directly alter the rate at which the tool will take-up the strap slack and the strap tension. Increasing or decreasing the VT air supply within the suggested 85 to 90 psig (5.7-6.2 Bar) range will not seriously affect the actual welding portion of the strap cycle.

After an initial "Break-In" period, the air motor may become more powerful. If the tool's performance is effected by this increase in performance, reduce the air motor output by turning the adjustment screw (Key 98) clockwise as required.

AIR SUPPLY INSTALLATION

If compressor has a good dryer unit, use black pickled pipe. When a dryer unit is not installed, use galvanized or copper pipe. To perform reliably, a pneumatic tool requires a continuous source of clean, water-free air at adequate pressure.



A filter-regulator-lubricator (FRL) unit must be installed as close to the air tool as possible, preferably within 10 feet. It should be placed in a convenient location where it can easily be drained, adjusted, and filled with oil. The air hose must have at least a 1/2" I.D. A quick disconnect socket fitting is installed on the stress spring end of the hose for convenient hookup to the air tool.

Filter-Regulator-Lubricator Unit, 1/2" NPT
(Signode Part No. 424773)

FRL Mounting Bracket
(Signode Part No. 071982)

Air Hose, 1/2" ID, 3/8" Fittings
(Signode Part No. 424774)

Quick Disconnect, 3/8" Fitting
(Signode Part No. 008569)

Reducer Bushing, 1/2" to 3/8"
(Signode Part No. 426767)

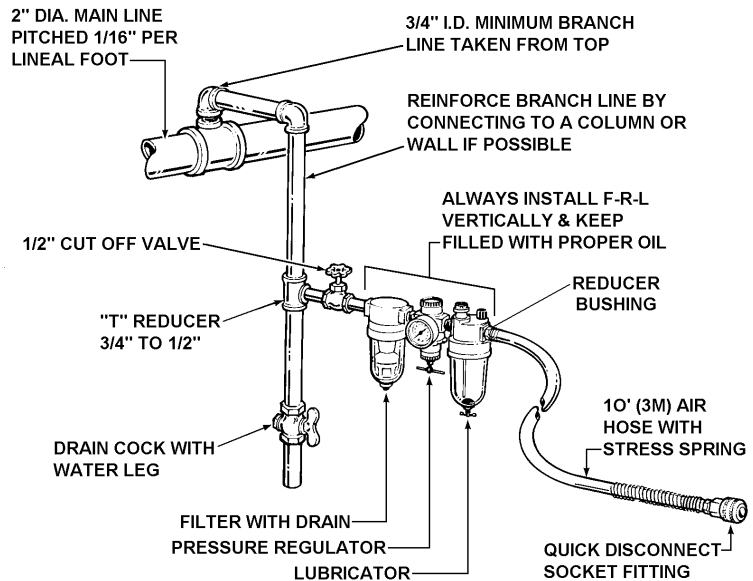

Filter and lubricator bowls are made of polycarbonate material. Do not install where bowls may be exposed to materials incompatible with polycarbonate. Certain oils, solvents, and chemicals or their fumes can weaken these bowls and possibly cause them to burst. Clean only with warm water. A cut-off valve placed ahead of the filter will be useful when cleaning the filter or replenishing the lubricator.

MOISTURE

Moisture is always present in air lines due to condensation within the lines as the air cools. Steps must be taken to remove this moisture and to keep it from the air tool. This is because water tends to wash away lubricants and cause corrosion, sticking and failure of internal parts.

The main line should be pitched so the far end terminates in a water leg. Branch lines are taken from the top of the main, never off the bottom. Every branch should have a water leg at its lowest point, with a drain cock which is drained daily.

If these precautions are taken and water is still present, an after cooler and a moisture separator are required between the compressor and the air receiver tank. A large air line separator can be installed in the air tool line, but precautions must be taken to insure that it will be drained daily, before the air tool is operated.

Water in air lines is a constant threat to the proper operation of air tool. Even near freezing operating conditions, a good refrigerant type dryer is essential. A good dryer will remove 95% or more of water right at the compressor. The remaining moisture is removed at the water leg in the piping system or in the filter (Part No. 008559).

NOTE: Additional information is available in the Signode publication, "Air Supply Manual" (Part No. 186038). If you have any questions, contact your local Signode Representative.

LUBRICATION

The air motor must be properly lubricated. This is achieved by keeping the air line lubricator filled with oil and correctly adjusted. Without proper lubrication, the motor will become sticky and the tool will give low and erratic tension and be difficult to release from the strap.

Install the lubricator as close to the air tool as possible. The arrow on the lubricator's top surface must point in the direction of air flow. For proper operation, oil must drop through the lubricator sight glass at a rate of 1 to 4 drops per minute. This rate is checked while the air tool is running free. Only 20% of this oil is actually delivered to the tool. The remaining oil drops back into the oil reservoir. The unit is factory set and should require no adjustment. If an adjustment is required, the adjusting screw on top of the lubricator may be turned as marked to reduce or increase the flow of oil.

The correct grade of oil must be used in the lubricator; too heavy an oil will not provide sufficient lubrication and will cause sticking and sluggish operation of the air tool. Recommended oils are any good grade of rust and oxidation inhibiting oil with a viscosity of 80-120 S.U.S. at 100 degrees Fahrenheit. (0.15 to 0.25 cm²/sec. at 38 degrees Celsius), such as:

Non Fluid Oil Co., grade #LS-1236

Signode oil - Part No. 008556

NOTE: Some oils contain anti-wear additives which may disable the air motor. Be certain to use recommended oil.

PNEUMATIC INFORMATION, Continued

Several drops of lubricator oil added to the inlet of the air motor or into the air line each day will help insure good operation. A noticeable reduction of air motor performance can usually be corrected by squirting a few drops of oil into the air line.

STRAP TENSION

Strap tension is controlled by turning the adjustment screw (Key 98) as shown by arrow, in 1/4 increment turns counter-clockwise to increase strap tension and clockwise to reduce strap tension.

NOTE: Operating air pressure must be set between 85 and 90 psi (5.7-6.2 Bar). With accurately controlled air pressure the tension will be uniform on all straps, provided the operator allows the air motor to stall.

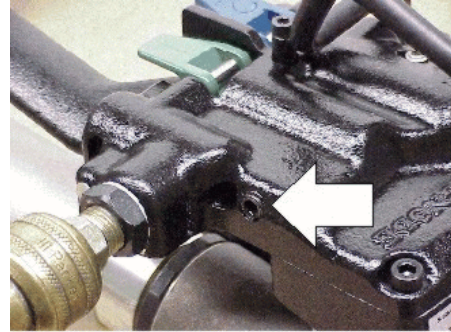

⚠ WARNING

Strap breakage hazard.
Strap can break if inlet air pressure to tool exceeds 90 psig (6.2 bar).
Strap breakage can result in severe personal injury.
Maximum operating air pressure is 90 psig (6.2 bar).

AIR CONSUMPTION

Air consumption in cubic feet per minute (cfm) for the VT can be calculated as follows: $cfm = (a) \times (b) \times (0.40)$

a = Number of straps applied per minute.

b = Number of seconds motor is on per strap during tensioning, from start to deceleration to stall including stall time while making joint.

0.40 = VT efficiency ratio.

Example Calculation: Peak strapping load is 4 straps/min. so a = 4
Air motor is on 5 seconds/strap, so b = 5
VT efficiency ratio is 0.40

$$(a) \times (b) \times (0.40) \rightarrow 4 \times 5 \times 0.40 = 8 \text{ cubic ft/min.}$$
$$4 \times 5 \times 0.67 = 13.4 \text{ cubic meters/hr. (13.4M}^3\text{/hr.)}$$

Air pressure is assumed to be 90 psig (6.2 Bar) with recommended size and length of air hose. Volume of air is at room temperature and sea level pressure, or so-called "free air" conditions. For more detailed information about air supply systems refer to Signode manual Part No. 186038.

COLD WEATHER OPERATION

Signode pneumatic powered tools operate reliably in a wide range of operating temperatures. However, operating conditions below an ambient temperature of 41 °F (5 °C) may require the compressed air to be dried. Dried air typically avoids any moisture and freezing tool issues.

Air motors typically use air compressed from 70 psi to 90 psi (4.8 to 6.2 Bar) and exhaust the compressed air approximately at 15 psi (1 Bar). The highly compressed air cycled through the tool, then exhausted to atmospheric pressure, may result in the discharged air freezing. Freezing air will contribute to reduced motor and tool performance.

Freezing air (icing) is a problem to all compressed air driven motors. Factors which can contribute to icing are:

- Compressed air vs. ambient air temperatures.
- Compressed air vs. ambient air dew points.
- Compressed air pressure.
- Flow rate of the compressed air exhausted through tool.
- Contaminated air quality.
- Cycle rate of tool.

If a tool does not operate satisfactorily in freezing temperatures, certain steps can correct the problem. The following steps can be taken to improve cold weather operation of the tool:

- a. Use of an air line dryer adjacent to the compressor.
- b. Use lubricant recommended by Signode. Signode has tested the use of anti-freezes, none work well in air tool; the tool will gum up when anti-freezes are introduced and will not function properly.
- c. If possible, run the air supply line to a indoor located Filter-Regulator-Lubricator or relocate the F-R-L to a warmer operating area.
- d. Eliminate any air line restrictions (review “Air Supply Installation” in this manual).

PNEUMATIC INFORMATION, Continued

AIR PRESSURE DROP

Confirm air pressure calibration by comparing it to a master gauge placed in-line where the quick disconnect fitting attaches to the tool.

Air pressure at the tool can then be monitored as the tool cycles. Use the following information shown on the chart below for comparing the various minimum air pressures while the VT tool cycles.

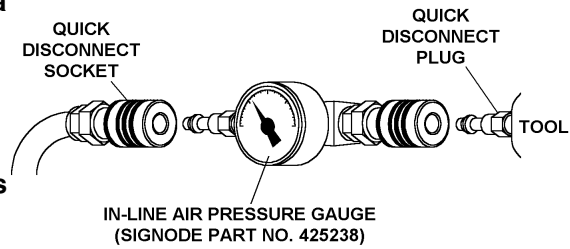

If pressure readings fall below the minimums, inspect your air supply system as well as the tool for worn and/or broken parts. Contact your Signode representative if you have any questions.

AIR LINE PRESSURE MINIMUMS FOR CYCLING TOOL

IN-LINE GAUGE READING PSI (BAR)			
SUPPLY/STATIC	TAKE-UP	STALL	WELDING
90 (6.2)	61 (4.1)	80 (5.4)	75 (5.2)

PNEUMATIC CIRCUIT DIAGRAM

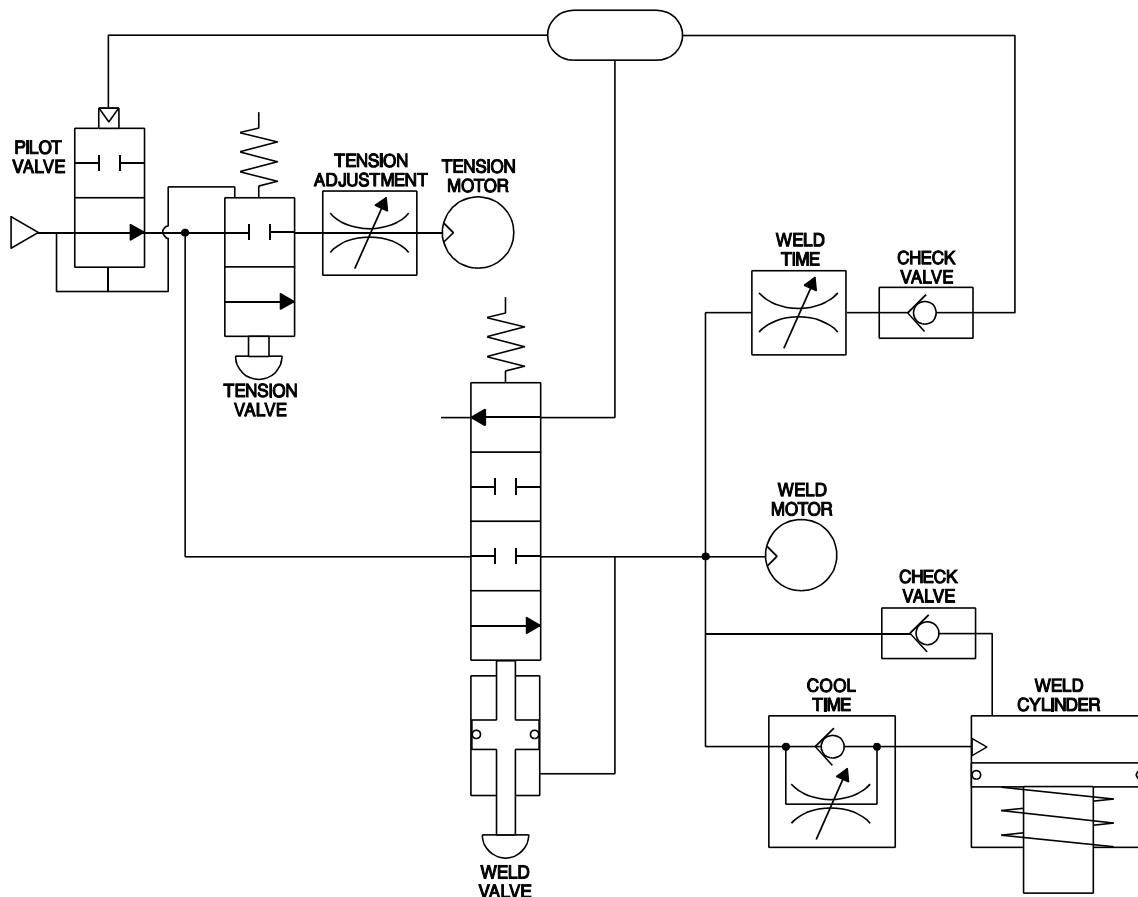

VT STRAP SIZE CONVERSION

NOTE: All parts named below to convert a VT tool can be found in the original shipping box.

Use the following instructions to convert (or reconfigure) a tool from 16mm strap to 19mm or vice versa.

1. The two inner guides (Key 73) must be reversed. Remove the mounting screw (Key 23) and reposition the guide so that the strap contact surface marked "16" or "19" is facing the strap path. Use Loctite #242 (or equivalent) when reinstalling the mounting screws.
2. The outer guide (Key 109) must be exchanged with the appropriate guide for the strap size (Signode P/N 423956 for 16mm and P/N 423957 for 19mm). Guides can be identified by the outer surface being marked "16" or "19". Remove the guide's mounting screw (Key 23) and install the proper guide. Use Loctite #242 (or equivalent) when reinstalling the mounting screw.
3. The guide plate (Key 86) must be exchanged with the appropriate guide plate for the strap size (Signode P/N 423978 for 16mm and P/N 423979 for 19mm). Guide plates can be identified by the outer surface being marked "16" or "19". Replace the guide plate by first removing support bar (Key 54) which is secured by two mounting screws (Key 4).

NOTE: The support bar fits tightly into the tool. Exercise care when removing so as not to cause any binding from end to end as it is removed.

Continue to remove the outer link (Key 60) and the existing guide plate (Key 86) at the same time.

4. Install the appropriate guide plate and outer link together as the parts are positioned on the tool. Reinstall the support bar making sure that the alignment pin (Key 95) installs into the slot of the new guide plate.
5. If desired, the tool nameplate may also now be exchanged to display the appropriate strap size (Signode P/N 423987 for VT-16 and P/N 423988 for VT-19).

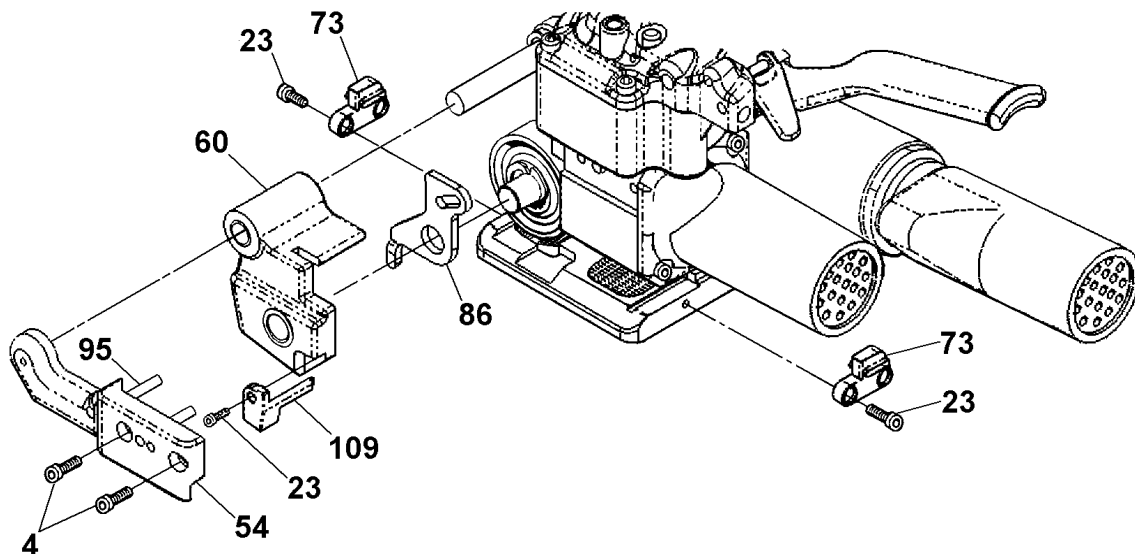

OPERATING INSTRUCTIONS

WARNING

**Wear safety glasses. Stand to one side of the strap when tensioning.
Make sure all bystanders are clear before proceeding.**

PLEASE NOTE: Do not operate tool without strap, as damage to the tool may occur.

1. With the dispenser placed behind you, bring the strap over the top and around the package, place the straps together and remove any excess slack.



2. Using your right hand, squeeze the tension motor and stationary handle together to open the feedwheel and strap path. Using your left hand, insert the overlapped straps under the feedwheel and through the welding mechanism.

Leave only a short tail ahead of the feedwheel and make sure straps are aligned behind the tool. Do not make a joint over a void area of the package.



3. Recheck the strap alignment at the rear of the tool and realign if necessary. Release the tension motor.

Press down the Green Tension Control Lever to begin tensioning the strap.

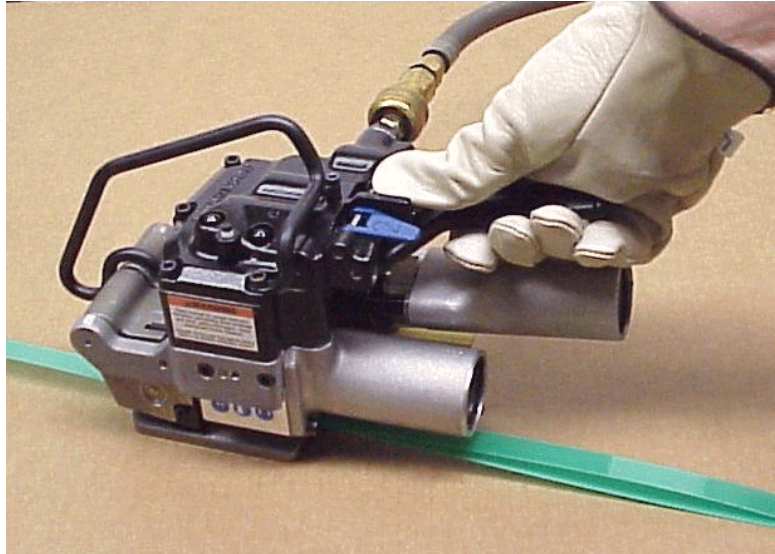

When the tension motor stalls, indicating completion of tension, release the control lever. The strap will remain tensioned around the package.

NOTE: If the strap alignment is unsatisfactory or the tool needs to be removed before sealing. Remove the tool as described in Step 5 of these instructions.

4. Press the Blue Sealer Control lever to begin the sealing cycle.



It is not necessary to continue holding the lever down once the weld cycle has started.

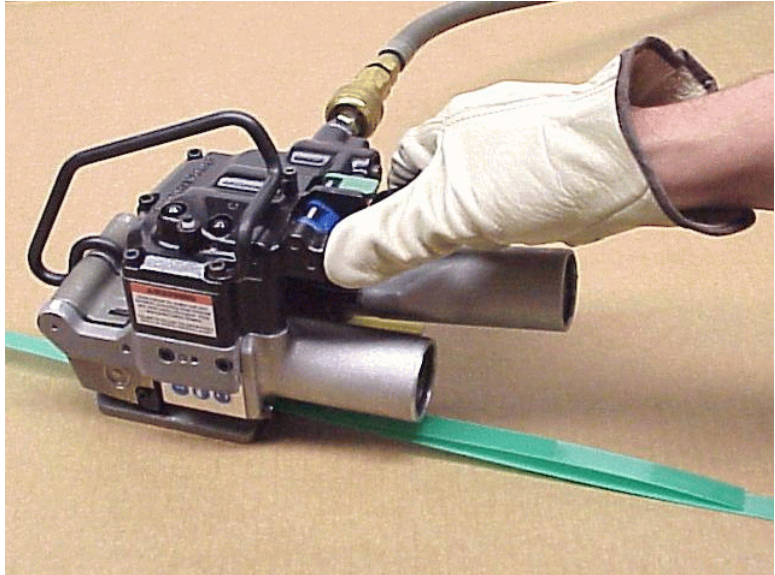

OPERATING INSTRUCTIONS, Continued

5. The internal weld timer is energized. The main piston brings the welding pads together and the strap is welded.

The supply end of the strap is then cut off. Pull the cut strap away from the tool during welding. The tool will continue through the weld cycle and stop automatically.

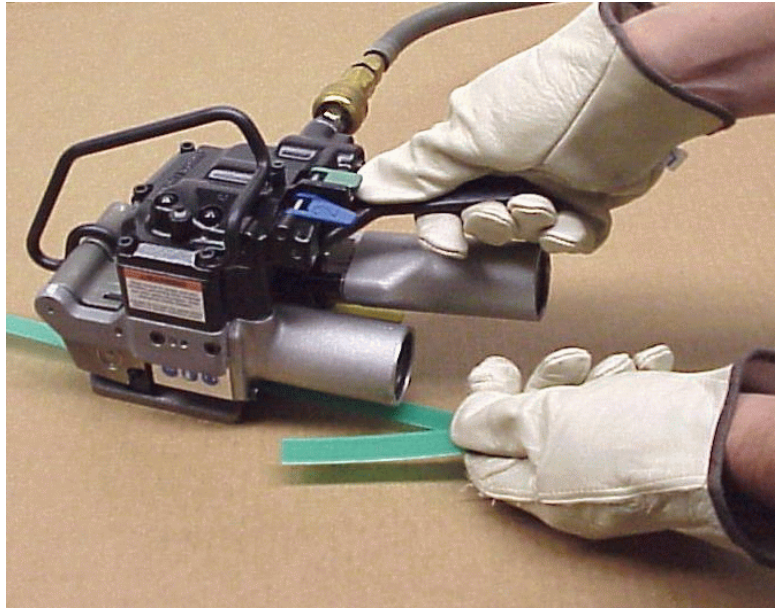

5. When the weld cycle has completed the weld mechanism slowly returns to the neutral position. This allows the newly welded strap joint to cool down properly. The tool can be easily removed once the weld mechanism has completely returned to the neutral position.

NOTE: The weld mechanism's return to the neutral position can be identified by the indicator located on the top of the tool. When the indicator is in the down position the weld mechanism is still engaging the strap. When the indicator is in the up position the weld mechanism has returned to the neutral position. The tool can then be easily removed from the strap.

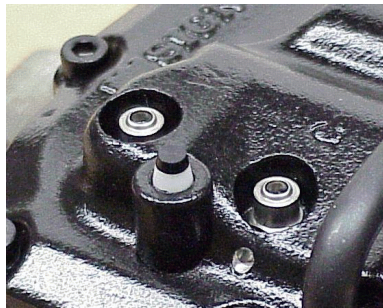

INDICATOR IN THE UP POSITION
(NEUTRAL)

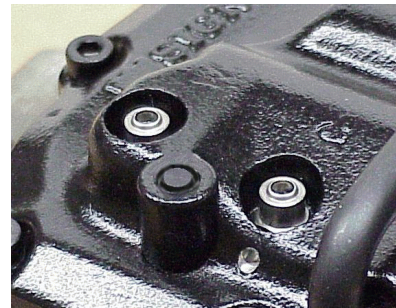

INDICATOR IN THE DOWN POSITION
(ENGAGED)

Remove the tool from the strap by first lifting up the tension release lever found on the bottom of the gear housing while squeezing the tension motor and stationary handle together to open the strap path.

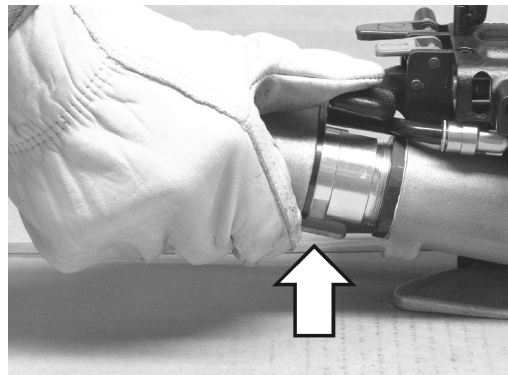

NOTE: Failure to wait for the weld mechanism to return to the neutral position may lead to an improperly formed joint which may lead to joint separation and make tool removal difficult.

6. Swing the tool out from the completed strap joint. Inspect the joint to make sure the straps have been properly welded.

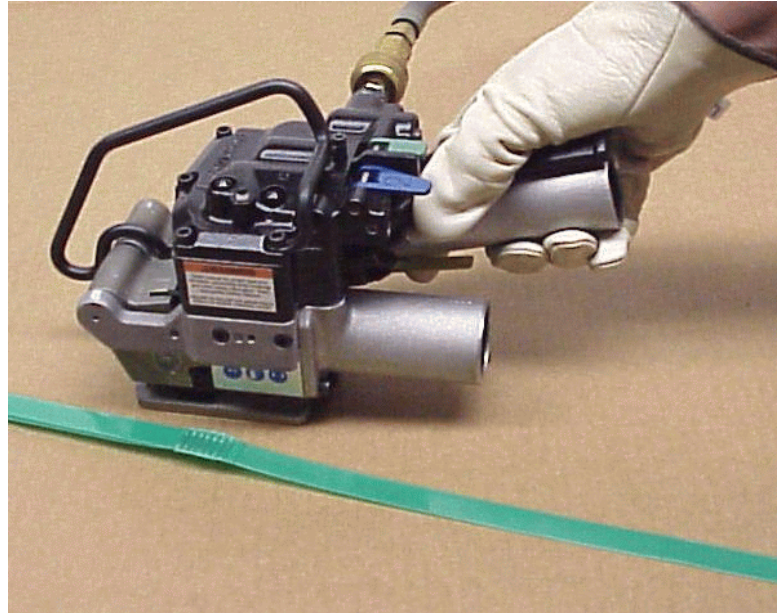

STRAP JOINT INSPECTION

This tool is a Tension Weld® type sealer. A properly made joint will appear as shown in the illustration. If the joint does not appear as shown, then the operator must proceed as follows:

1. Insure that the tool operating instructions are being followed before applying another strap.
2. Cut the strap off and apply another.

A good weld will show some material displacement along the edges. The welded area should extend the full length and width of the gripper impression.



If the joint still does not appear as shown, then inspect the tool for worn and/or damaged parts. Replace tool parts as needed. **NEVER HANDLE OR SHIP ANY LOAD WITH IMPROPERLY FORMED JOINTS.** Misformed joints may not secure the load and could cause serious injury.

TOOL ADJUSTMENTS

WELDING TIME

Weld time has been factory adjusted to provide acceptable weld strength when using High Strength Tenax (polyester) type strap. Weld time may need to be adjusted due to air supply differences, tool wear, etc. Adjustments are made by turning the adjustment screw, located on the cover plate, using a small screwdriver. Turn the screw clockwise to increase weld time and counterclockwise to decrease weld time.

Establishing the correct weld time is a matter of trial and error and should be conducted as follows.

1. Remove the cap which protects the adjustment screw. Adjust the screw in 1/8 to 1/4 turn increments only.
2. Apply a strap and make a weld.
3. Compare the weld made with the illustrations shown on page 13 of this manual. A good weld will displace some material along the outer edges of the joint.
4. If you are unable to produce an acceptable joint or if you have any questions as to whether your tool is producing good weld strength, contact your Signode Sales Representative.
5. Replace the cap over the screw.

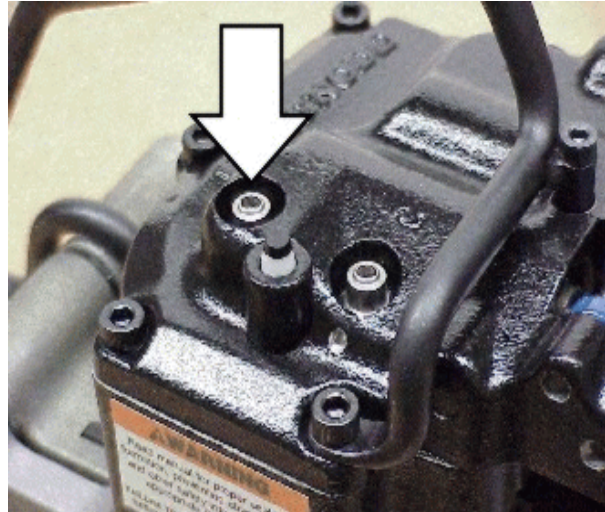

LOCATION OF WELD TIME ADJUSTMENT

WELD COOLING TIME

Cool time has been factory adjusted to allow the proper time for a weld to properly cool. The cool time adjust controls how fast or slow the main piston bleeds off air pressure allowing the weld pads to separate from one another.

Cool time may also need to be adjusted due to air supply differences, tool wear, etc. Adjustments are made similar to weld time. Turning the screw clockwise increases cool time and counterclockwise to decrease cooling time.

Establishing the correct cool time is a matter of trial and error and should be conducted as follows.

1. Remove the cap which protects the adjustment screw. Adjust the screw in 1/8 to 1/4 turn increments only.
 2. Apply a strap and make a weld.
 3. A properly adjusted cool time should allow the strap joint to cool for approximately two to three seconds.
- NOTE: Cool time which is too short may lead to strap joint separation.*
4. Replace the cap over the screw.

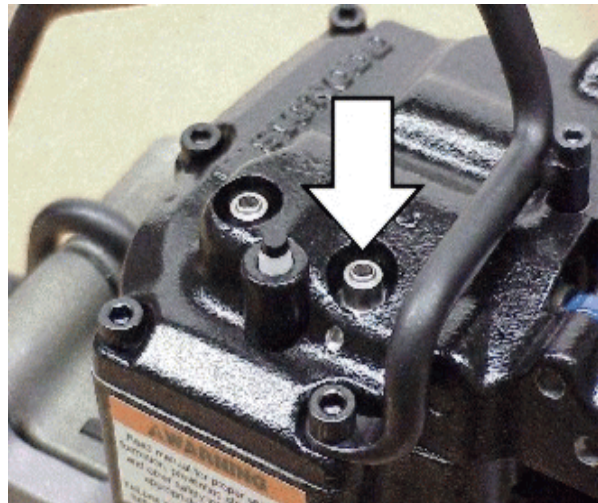

LOCATION OF COOL TIME ADJUSTMENT

FEEDWHEEL TO GRIPPER PLUG

The feedwheel to gripper plug clearance may require readjustment if the feedwheel or gripper plug has been replaced. The feedwheel clearance should also be inspected during routine tool maintenance procedures. Adjust the feedwheel clearance as follows:

1. Squeeze the tension motor and stationary handle together to open the feedwheel gap. Place multiple (4 to 8) layers of .002", 1/2" wide (.05 x 12mm) shim stock between the feedwheel and the gripper plug.

NOTE: Do not use a single shim such as .008" (.20mm) as thicker shims may not conform to the feedwheel shape, resulting in inaccurate clearance measurements.

2. Release the tensioner motor to pinch the shims between the feedwheel and the gripper plug. Holding the shims with one hand, jog the tension motor on and off to rotate the feedwheel at least one full revolution. If properly adjusted the tool should lightly tug at the shims while rotating. Clearance between the feedwheel and gripper plug at this point should fall between .008" to .016 (.20mm to .40mm).

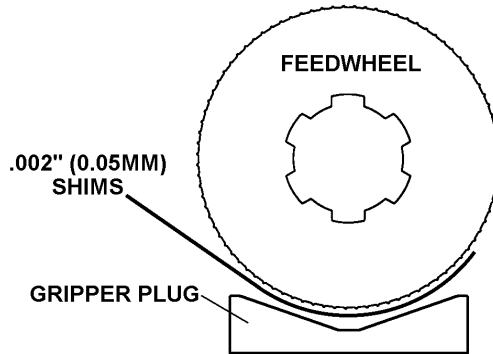

3. If the feedwheel needs to be adjusted, use a 3mm hex wrench to turn the adjustment screw which can be accessed through the bottom of the tool base.

Turn the adjustment screw clockwise for greater clearance and counter-clockwise for less clearance. Turn the adjustment screw only in 1/8 turn increments. After each 1/8 turn, repeat the adjustment testing as described in step 2.

4. Once the proper clearance has been found the tool can be returned to service.

NOTE: Never turn out the adjustment screw more than 1/8 turn at a time without testing or completely remove the adjustment screw. These actions will severely damage both the feedwheel and gripper plug.

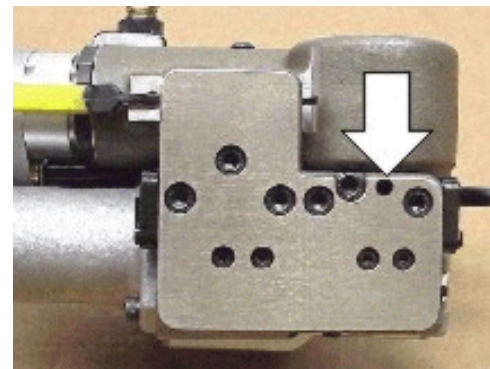

FEEDWHEEL ADJUSTMENT SCREW LOCATION (ARROW)

STRAP TENSION

Strap tension is controlled by turning the adjustment screw (Key 98) as shown by arrow, in 1/4 increment turns counter-clockwise to increase strap tension and clockwise to reduce strap tension. Use the 4mm hexwrench (Signode Part No. 274467) included with every new tool.

NOTE: Operating air pressure must be set between 85 and 90 psi (5.7-6.2 Bar). With accurately controlled air pressure the tension will be uniform on all straps, provided the operator allows the air motor to stall.

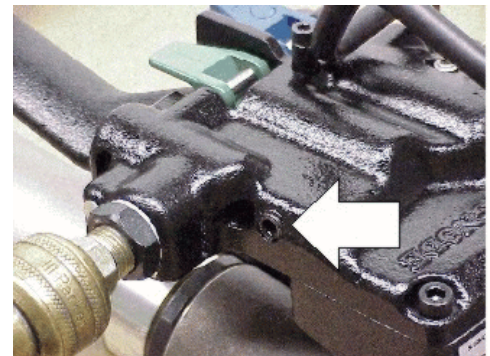

TOOL ADJUSTMENTS, Continued

STRAP CUTTER

The VT strap cutter has two serrated cutting edges. After the first edge has become dull or strap cut-off becomes difficult the blade can be remounted to use the second cutting edge. Once both edges have become worn the blade should be replaced. Use the instructions below to remount, install and adjust a new cutter blade.

1. Remove the two mounting screws which secure the air motor to the tool body. Remove the weld motor from the tool by turning the motor counter-clockwise to release the O-ring which seats on the top of the motor.

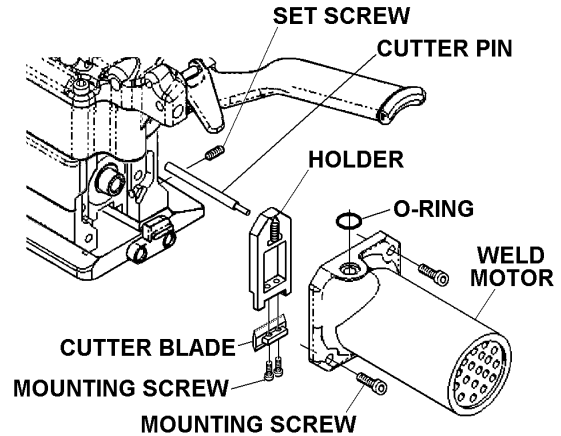

NOTE: The small spring contained in the holder does not need to be removed to change the cutter blade.

2. The cutter blade group of parts can now be removed from the tool. Continue to also remove the cutter pin from the tool.
3. Remove the two smaller screws which mount the cutter blade to the holder. Rotate the cutter blade to the new cutting edge and reinstall the mounting screws.

NOTE: If both cutting edges are worn replace the cutter blade at this point.

4. Reinstall the cutter group of parts back into the tool. Before installing the cutter pin inspect the cutter holder movement within the tool.
 - A. The holder should move freely up and down in the tool body. If the holder does not move freely inspect the tool for debris or damage.

NOTE: If the holder has been replaced it may be necessary to adjust the set screw which controls the side clearance.

- B. The holder should not be able to move from side to side. Excessive side to side clearance will result in poor strap cut-off. If the holder does move side to side, tighten the set screw until it just touches the side of the holder, approximately a 0.025mm (0.001") clearance.

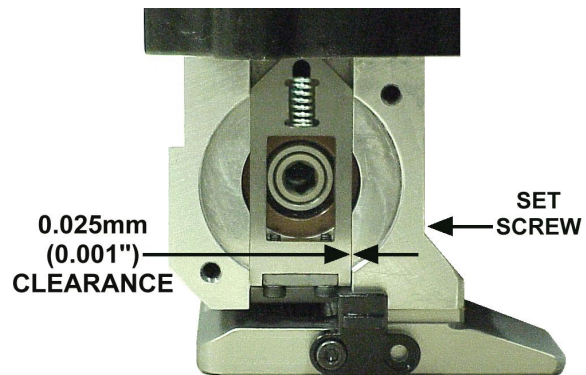

5. Once the cutter holder has been inspected and adjusted, continue to reinstall the remaining parts in the order that they were removed.
6. Run a few test cycles on the tool to confirm that the strap cut-off performs properly.

TROUBLESHOOTING

The following items are the most common types of tool malfunctions. For symptoms or remedies not shown, contact your Signode service representative for additional information and details. The following tool conditions are shown in this manual:

AIR SUPPLY

- #1 - The air motor is frozen.
- #2 - A leaking or sticking air valve.
- #3 - The tool runs sluggishly.

TENSIONING

- #4 - Feedwheel milling on strap and/or strap breaking.
- #5 - The top strap is being properly tensioned but the tool does not hold the bottom strap.

WELDING

- #6 - A poor weld identified by an incomplete area of weld.
- #7 - Incomplete or no weld.
- #8 - Strap is over welded.
- #9 - Motor shut-off is sluggish.
- #10 - Strap weld time is erratic.
- #11 - Weld time is too long.

CUT-OFF ACTION

- #12 - The cut-off has become difficult.
- #13 - Weld strap is misaligned.

#1 CONDITION: The air motor is frozen.	
CAUSE	REMEDY
The motor is dry, hindering it from providing maximum performance.	Add several drops of oil into the motor through the air inlet. Hook the tool up to air, depress and hold the operating lever while gently tapping the motor with a rubber mallet. Repeat this procedure several times if necessary.

#2 CONDITION: Air valve leaking or sticking.	
CAUSE	REMEDY
Worn, damaged or dirty O-rings on valve assemblies.	Clean and lubricate the valve assemblies and the valve sleeve assembly. Replace the O-rings on the valve assemblies if necessary.

TROUBLESHOOTING, Continued

#3 CONDITION: The tool runs sluggishly.	
CAUSE	REMEDY
1. The air filter-regulator-lubricator is malfunctioning or is not properly maintained.	1A. Check the regulator to see that the correct air pressure is getting to the tool. 1B. Check to see the filter unit is clean and functioning properly. 1C. Examine the lubricator to see there is oil in the bowl and that oil is seen dripping from the sight dome as the tool operates. This assures the air motor is being properly lubricated.
2. The tool may run sluggishly due to a clogged or dirty motor filter screen due to a lack of properly filtered air supply.	2. Remove the Hansen plug at the inlet to the air motor and examine the filter screen in the filter assembly and clean it if necessary.
3. The tool may run sluggishly due to an improper air motor adjustment or a clogged or dirty vibrator assembly.	3. Clean vibrator parts as needed. Inspect vibrator eccentric for wear or damage. Replace as required.
4. The end plates, pinion teeth on the rotor and the rotor blades are worn, dirty or rusted.	4. Carefully remove the air motor from the tool and disassemble it. If these parts are only dirty, clean, thoroughly oil and reassemble. If they are worn or rusted, replace them.

#4 CONDITION: Feedwheel milling on strap and/or strap breaking.	
CAUSE	REMEDY
1. Feedwheel is clogged with dirt or strap residue.	1. Clean teeth on feedwheel with the cleaning brush provided.
2. Worn teeth on the feedwheel.	2. Replace the feedwheel.
3. Excessive or improperly set feedwheel to gripper plug clearance.	3. Adjust feedwheel gap as required.

#5 CONDITION: The top strap is being properly tensioned but the tool does not hold the bottom strap.	
CAUSE	REMEDY
1. The gripper plug may be packed with dirt or strap residue preventing the teeth from penetrating the strap.	1. Clean teeth on gripper plug with the cleaning brush provided.
2. Worn teeth on the gripper plug.	2. Replace the worn plug. Since the feedwheel and gripper plug are prevented from contacting one another by an inside shoulder on each part, it is not often these parts have to be replaced.
3. The tension release lever is being held while operating the tool.	3. Review the operating instruction shown in this manual.

#6 CONDITION: A poor weld identified by an incomplete area of weld.	
CAUSE	REMEDY
Welding is achieved by a combination of vibration and downward pressure of the upper gripper. Either a restriction of motion or a reduction of downward pressure will cause a poor weld.	Dismantle and clean the weld mechanism by brushing away the strap residue or washing the entire unit in a solvent. When a solvent is used it is imperative the assembly be blown dry to remove all solvent. Check for dry or worn bearings. Replace or lubricate as required. If the tool has been used extensively, examine the teeth on the upper and lower weld pads for wear. Replace if worn.

#7 CONDITION: Incomplete or no weld.	
CAUSE	REMEDY
1. Improperly set weld time adjustment.	1. Adjust weld time as required per instruction in this manual.
2. Worn teeth on upper or lower weld pads.	2. Replace as required.
3. Insufficient air supply pressure.	3. Remedy as required.
4. Worn o-ring on main piston.	4. Replace as required.

#8 CONDITION: Strap is over welded.	
CAUSE	REMEDY
Improper weld timing adjustment.	Decrease weld timing as needed.

#9 CONDITION: Motor shutoff appears sluggish.	
CAUSE	REMEDY
1. Air leakage in timing circuit.	1. Check o-rings and pneumatic components for leaks. Replace parts as required.
2. Dirty or very dry pilot valve (Key 106).	2. Remove, clean and lubricate the pilot valve using air line oil or replace if needed.
3. Dirty or very dry sealer valve stem (key 72).	3. Remove valve stem and inspect o-rings for damage. Replace o-rings as needed. Clean part and lubricate with EP Accrolube grease.

TROUBLESHOOTING, Continued

#10 CONDITION: Strap weld time is erratic.	
CAUSE	REMEDY
1. Air leakage in timing circuit.	1. Check o-rings and pneumatic components for leaks. Replace parts as required.
2. Dirty or very dry pilot valve (Key 106).	2. Remove, clean and lubricate the pilot valve using air line oil or replace if needed.
3. Weld time flow control (Key 88) is contaminated with debris or oil.	3. Remove part and clean using dry compressed air.

#11 CONDITION: Weld time is too long.	
CAUSE	REMEDY
Too much oil in the air supply system of the tool.	Purge the tool of all excess oil.

#12 CONDITION: The cut-off has become difficult.	
CAUSE	REMEDY
1. Strap residue jamming cutter mechanism.	1. Clean parts as required.
2. Cutter blade worn or damaged adjustability.	2. Replace as required.

#13 CONDITION: Welded strap is misaligned.	
CAUSE	REMEDY
1. The tool is not being operated properly.	1. Review operating instruction shown in this manual for proper operation of tool.
2. Teeth of upper weld gripper (Key 62) or lower weld gripper (Key 50) are damaged.	2. Replace damaged parts as needed.
3. Teeth of feedwheel (Key 47) or tension gripper (Key 48) are damaged.	3. Replace damaged parts as needed.

MAINTENANCE

TOOL

- 1. Clean the teeth on the feedwheel and the gripper plug with the special brush provided.**
- 3. Periodically clean the tool with compressed air.**
- 4. Disassemble, clean and lubricate the welding mechanism.**

GEAR HOUSING

Periodically check the gear housing portion of the tool:

- 1. Remove the end cap from the front of the gear housing by removing the set screw and pulling the end cap off.**
- 2. Check for adequate lubrication and wear of the Spiroid worm gear and ring gear.**
- 3. This portion of the tool should be one-third full of gear grease.**
- 4. Reinstall the end cap.**

OVERHEAD SUSPENSION

To work effectively, your VT tool must be properly installed. This installation includes, in some cases, proper suspension of the tool over the container to be strapped, and the proper placement of a strapping dispenser to provide a continuous easy supply of strapping for the application. The VT can be suspended in various operating positions by using the proper tool hanger and hardware.

Review the illustrations below for the appropriate configuration for the tool application. Applications are recommended to use an Overhead Tool Balancer as shown (Signode Part No. 306809).

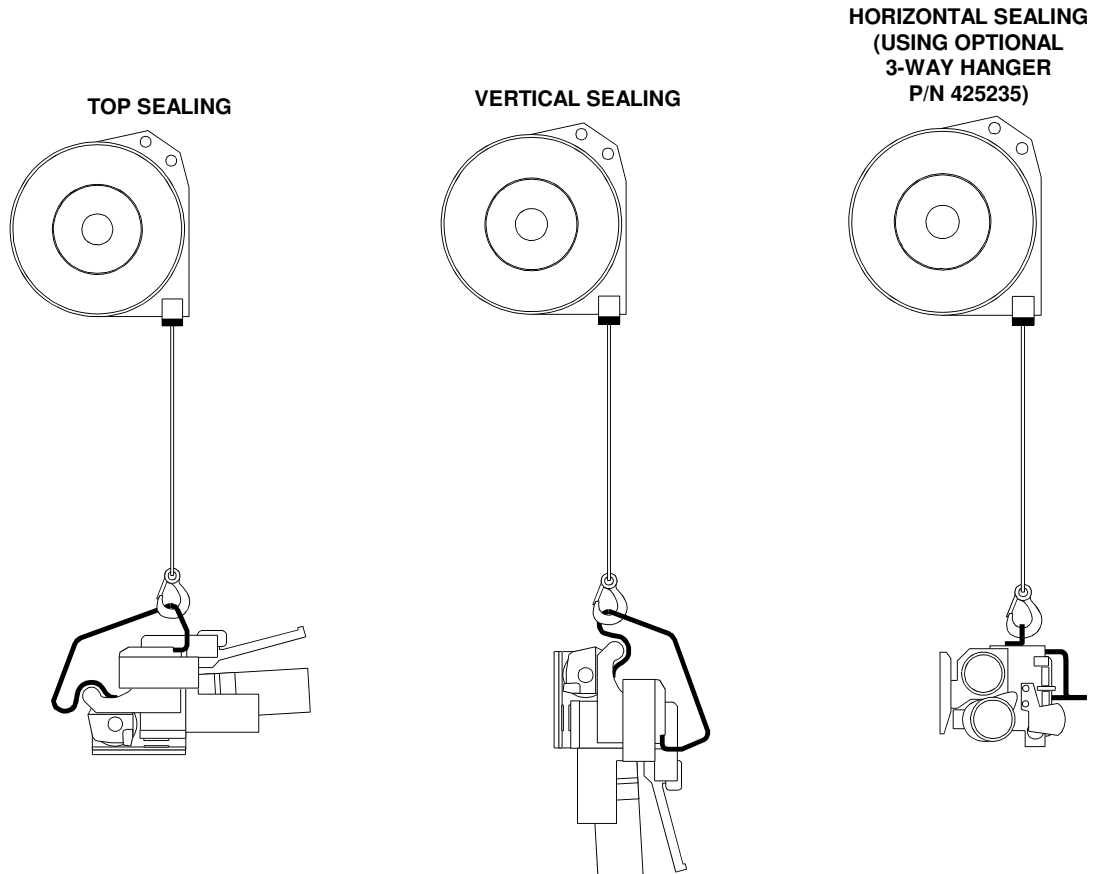

TOOL OPTIONS

TENSION LATCH KIT

This option makes the VT tool easier for the operator to use. The tension control lever only needs to be pressed one time to fully tension a load. This option eliminates the need to hold down the tension control for the entire tension cycle. Once the tool's sealer control is engaged the tension latch automatically releases and resets.

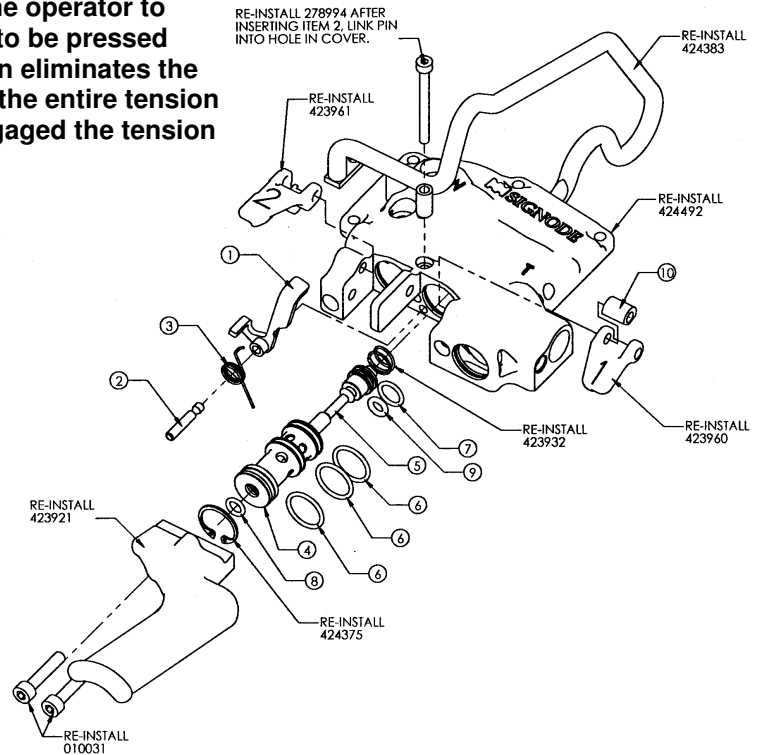

3-WAY TOOL HANGER

This option allows the operator to suspend the VT tool from its side to allow for easier horizontal strapping applications as well as top and side sealing applications. The hanger replaces the standard VT tool hanger.

NOTE: Hanger is supplied with additional M5x16 socket head cap screws (Part No. 170304) for mounting the hanger to the tool.

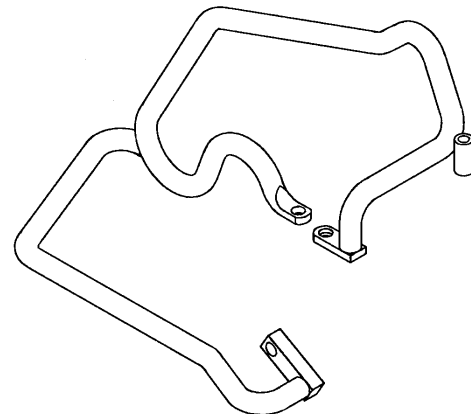

HEAVY DUTY TOOL BASE

This optional tool base replaces the standard base of the VT tool. The heavy duty base is recommended for increasing tool life in rough operating conditions. This part is replaced using the existing mounting hardware of the standard tool base.

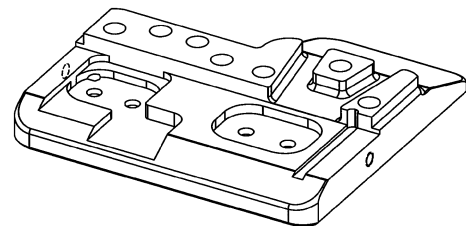

OPTIONAL WEAR RING

An optional wear ring is available to protect the tension motor from harsh operating environments. This wear ring can be used with either the VT-16 or the VT-19 tools. To install the wear ring spread open the ring gap using an appropriate spreading tool. Begin to slip the ring over the end of the tension motor. Using a rubber mallet, gently tap the wear ring down onto the end of the air motor.



OPTIONAL MOTOR GUARD

An optional motor guard is available to protect the motor gear housing from harsh operating environments. This motor guard can be used with either the VT-16 or the VT-19 tools. Install the motor guard to the bearing cap using two M5 x 8 button head cap screws. The white tension piston must be raised by hand to install the guard under piston. Once properly installed, the tension piston should contact the motor guard.

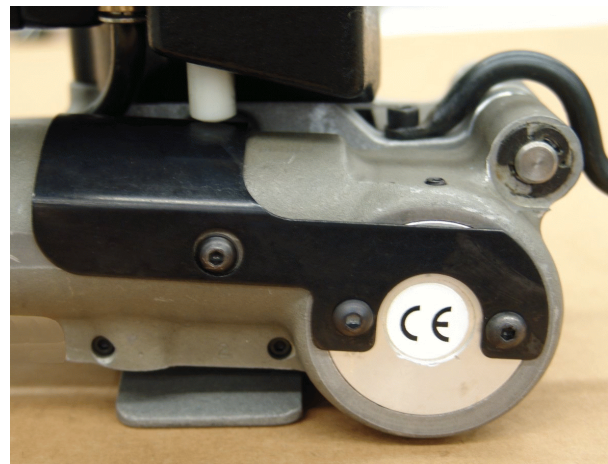



EU Declaration of Conformity
The Supply of Machinery (safety) Regulations
1992 (S.I. 1992/3073)

It is hereby declared that the undermentioned machinery has been designed and constructed to comply with the health and safety requirements defined in EC Directive 89/392/EEC

Machine Supplier: Signode, Division of ITW Ltd.
Queensway, Fforestfach
Swansea SA5 4ED

Machine Description: VT Series

Machine Type: Pneumatic Combination Hand Strapping tool.

Provisions with which machine complies:

89/392/EEC, 91/368/EEC

Harmonized EuroNorms with which machine complies:

EN 292:1, EN 292:2, EN 294, EN 349

Technical Standards with which machine complies:

NA

Signature:

A handwritten signature in black ink, appearing to read 'Peter Oseland', with a horizontal line underneath.

Date: 4 June 2003

(Peter Oseland)

SIGNODE NEW TOOL WARRANTY

Signode Engineered Products Warrants that a new Signode strapping tool will operate per functional specifications for a period of sixty (60) days after the date of shipment to the owner's place of business. Normal wearing parts, as outlined in the Operation, Parts & Safety manual, are covered by a thirty (30) day warranty unless, in Signode's judgement, these parts have been subjected to abnormal or extreme usage. Signode's sole liability hereunder will be to repair or replace, without charge, F.O.B. Signode's Glenview, Illinois plant, any tool which proves to not operate per functional specifications within the stated period. Signode reserves the right to replace any tool which proves not to operate per functional specifications with a new or like-new tool of the same model if in Signode's judgement such replacement is appropriate. Any new replacement tool provided to an owner will carry a full sixty (60) day warranty. Any warranty repaired tool or like-new replacement tool will carry a warranty for the balance of the time remaining on the initial sixty (60) day warranty. This warranty will be extended to compensate for the time the tool is in Signode's possession for warranty repairs.

This warranty is void as to any tool which has been: (I) subjected to mis-use, misapplication, accident, damage, or repaired with other than genuine Signode replacement parts, (II) improperly maintained, or adjusted, or damaged in transit or handling; (III) used with improperly filtered, unlubricated air or improper strapping material, (IV) in Signode's opinion, altered or repaired in a way that affects or detracts from the performance of the tool.

SIGNODE MAKES NO WARRANTY, EXPRESSED OR IMPLIED, RELATING TO MERCHANTABILITY, FITNESS OR OTHERWISE EXCEPT AS STATED ABOVE AND SIGNODE'S LIABILITY AS ASSUMED ABOVE IS IN LIEU OF ALL OTHERS ARISING OUT OF OR IN CONNECTION WITH THE USE AND PERFORMANCE OF THE TOOL. IT IS EXPRESSLY UNDERSTOOD THAT SIGNODE SHALL IN NO EVENT BE LIABLE FOR ANY INDIRECT OR CONSEQUENTIAL DAMAGES INCLUDING, BUT NOT LIMITED TO, DAMAGES WHICH MAY ARISE FROM LOSS OF ANTICIPATED PROFITS OR PRODUCTION, SPOILAGE OF MATERIALS, INCREASED COSTS OF OPERATION OR OTHERWISE.

Considerable effort has been made to ensure that this product conforms to our high quality standards. However, should you experience any difficulties, please contact your Sales Representative providing samples and the manufacturing code specified on the tool.